

TUBESCA-COMABI

LE TOP EN PROMO

JUSQU'AU 31 MAI 2025

TOP #1 AXESS

NOUVEAU

DOUBLE ACCÈS

- Avec ou sans garde-corps +
- Surface d'appui confortable +

À PARTIR DE
116 €HT

p.14



DÉSORMAIS SUBVENTIONNABLE

Z'TOWER

- 7 hauteurs de travail +
- Montage moins de 2 min +

À PARTIR DE
1862 €HT

p.11



EQUIPEMENTS DE CHANTIER



X'TOWER

- kit de chargement offert +

À PARTIR DE
2611 €HT

p.11



NOUVEAU

LOTS R200 PRIMO 60 M²

- Robustesse de l'acier +
- Versions planchers RCE ou planchers alu/bois +

À PARTIR DE
5415 €HT

p.2

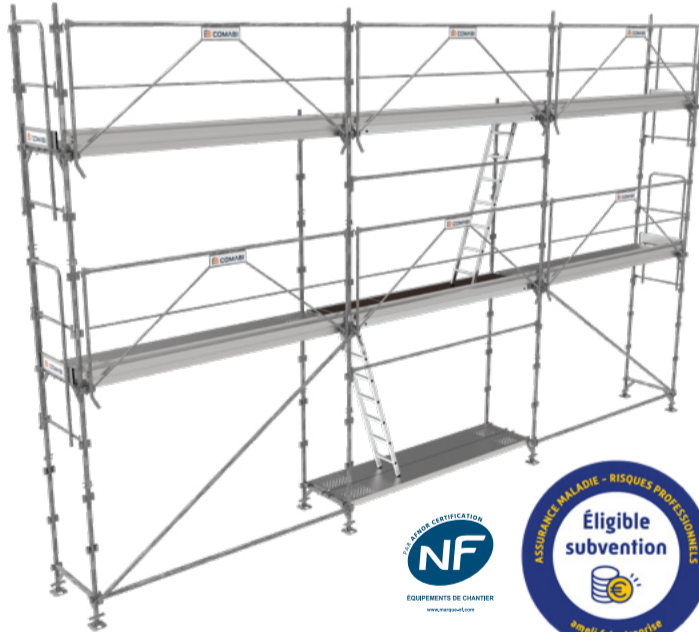

EQUIPEMENTS DE CHANTIER



RAPTORSCOPIC

- Télescopique +
- Garde-corps sangles ou lisses +

À PARTIR DE
812 €HT

p.18



- Existe en versions garde-corps pliant



SUBVENTIONS TOP BTP

Bénéficiez jusqu'à **25 000€** de subvention pour l'achat de nos produits éligibles.

50% DU MONTANT HT DES SOMMES ENGAGÉES

Demande de réservation via net-entreprises.fr



NOUVEAU

SUBVENTIONS MONTE-MATÉRIAUX

+ d'infos p.17

Jusqu'à **70%** d'aide à l'achat de nos Apache, Nevada et Montana.

PRIX PROMO
256 €HT

p.17

KIT PANNEAUX PHOTOVOLTAÏQUES

COMPATIBLE AVEC NOS MONTE-MATÉRIAUX APACHE ET NEVADA



LOTS R200 GARDE-CORPS LISSES



MEDIUM 104 M²

- L : 12,00 m - H : 6,00 m plancher
- Surface de travail 13 x 8 m
- 3 lots de 3 amarrages recommandés ⁽¹⁾
- 1 version : acier

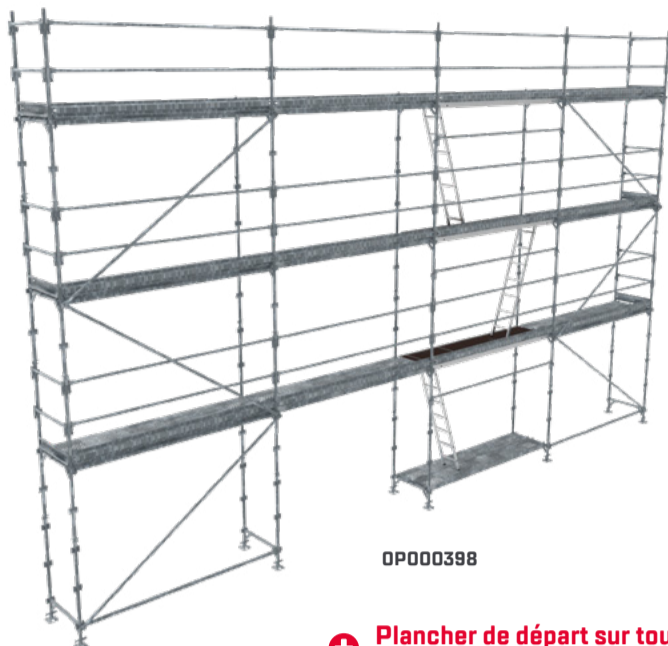

OP000398

+ Plancher de départ sur tous nos lots R200 pour + de confort

MEDIUM 130 M²

- L : 12,00 m - H : 8,00 m plancher
- Surface de travail 13 x 10 m
- 3 lots de 3 amarrages recommandés ⁽¹⁾
- 1 version : acier

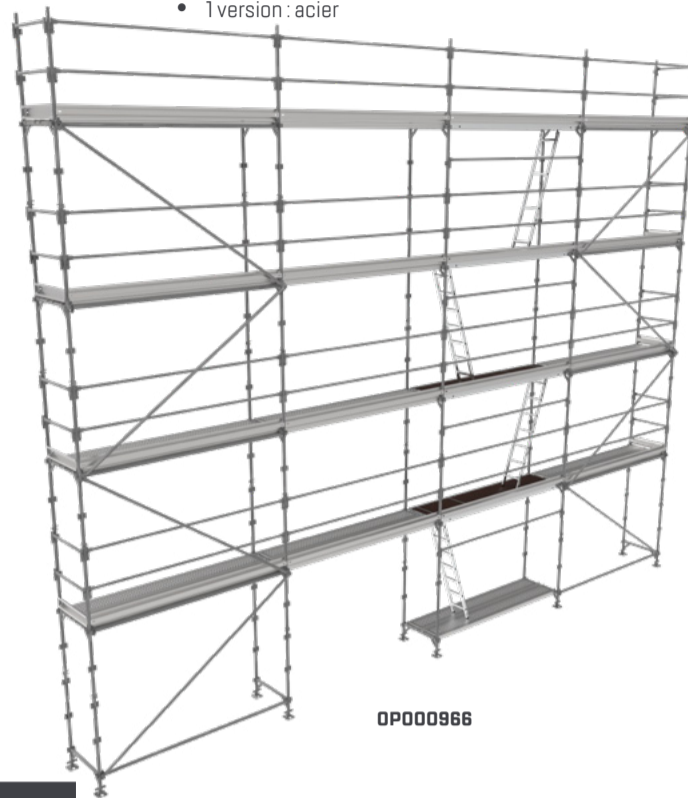

OP000966

COMPOSITION

Code	Désignation	Lot	ACIER			
			FIRST 80 m ²	MEDIUM 104 m ²	MEDIUM 130 m ²	PREMIUM 160 m ²
04101003	RCM24 Socle à vis articulé débattement 0,45 m (Ø38 mm)	8	10	10	12	12
04002009	R1 Cadre de départ en U 1,20 m - Acier	4	5	5	6	6
04002004	R3 Cadre en H 2,00 m - Acier	10	12	17	20	20
04002006	R4 Cadre 2,00 m asymétrique - Acier	2	3	3	4	4
04204043	Longeron forte charge 3,00 m	8	8	10	10	10
00010520	RCM630 Lisse latérale 3,00m	21	27	36	44	44
04005005	RCM30 Diagonale verticale indexée, maille 3,00 x 2,00m	6	6	8	8	8
00010550	RCM608 Lisse d'extrémité 0,80 m	12	12	16	16	16
04010335	Plancher R08-CT3000X730	3	3	4	4	4
04010001	RCE300 - Plateau acier 3,00 m largeur 0,36 mm	14	20	26	34	34
02460034	RCM48 Échelle Aluminium	3	3	4	4	4
04010201	PC300 Plinthe acier 3,00 m	9	12	16	20	20
04010208	PC080 Plinthe acier 0,80 m	6	6	8	8	8
00035775	Notice R200	1	1	1	1	1

LOT	ACIER	CODE PROMO Gencod	PRIX PROMO Tarif 2025
10	80 m ² PROGRESS FIRST garde-corps lisses + planchers acier + plinthes	OP000396 3534740159744	6478 €HT 14834 €HT
11	104 m ² PROGRESS MEDIUM garde-corps lisses + planchers acier + plinthes	OP000398 3534740159768	8158 €HT 17898 €HT
12	130 m ² PROGRESS MEDIUM garde-corps lisses + planchers acier + plinthes	OP000966 3534740178073	10404 €HT 22936 €HT
13	160 m ² PROGRESS PREMIUM garde-corps lisses + planchers acier + plinthes	OP000400 3534740159782	12297 €HT 26878 €HT

⁽¹⁾ Préconisation pour une structure non recouverte

LOTS R200 GARDE-CORPS LISSES



BUDGET 60 M²

- L : 9,00 m - H : 4,00 m plancher
- Surface de travail 10 x 6 m
- 1 lot de 3 amarrages recommandé
- 1 version : acier



OP000581 + OP000582

BUDGET 78 M²

- L : 12,00 m - H : 4,00 m plancher
- Surface de travail 13 x 6 m
- 1 lot de 3 amarrages recommandé
- 1 version : acier

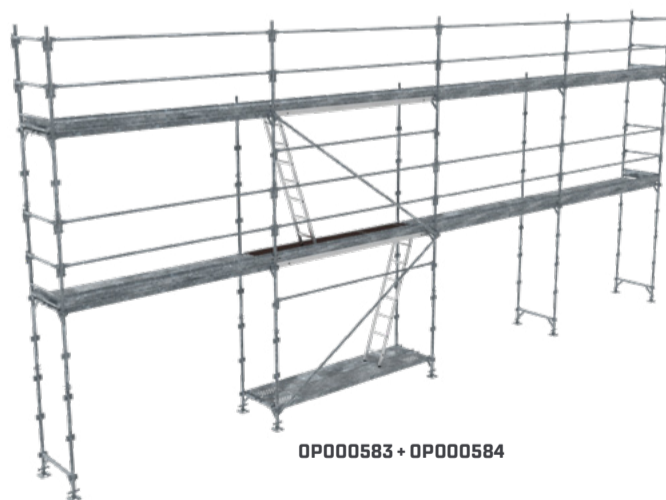

OP000583 + OP000584

BUDGET 128 M²

- L : 15,00 m - H : 6,00 m plancher
- Surface de travail 16 x 8 m
- 2 lots de 3 amarrages recommandés
- 1 version : acier

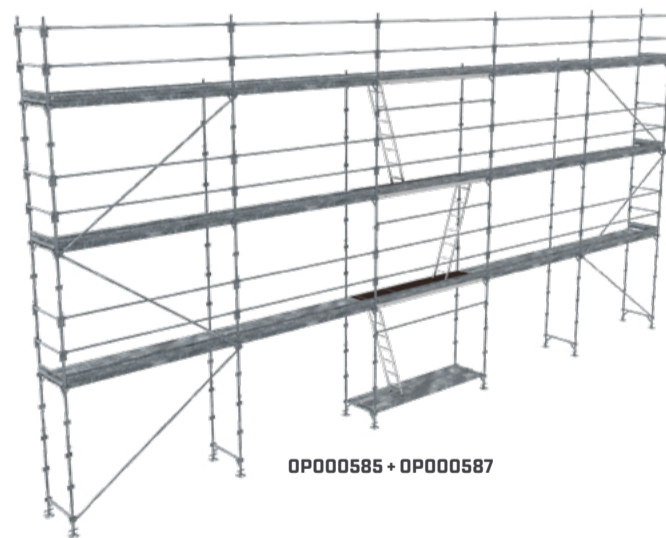

OP000585 + OP000587

+ Plancher de départ sur tous nos lots R200 pour + de confort

LOT	ACIER	CODE PROMO Gencod	PRIX PROMO Tarif 2025
14	R200 PROGRESS BUDGET 60 m ² (pack structure et planchers)	OP000581 3534740168173	4097 €HT 9146 €HT
14*	R200 PROGRESS BUDGET 60 m ² (pack plinthes)	OP000582 3534740168180	269 €HT 468 €HT
15	R200 PROGRESS BUDGET 78 m ² (pack structure et planchers)	OP000583 3534740168197	5093 €HT 11208 €HT
15*	R200 PROGRESS BUDGET 78 m ² (pack plinthes)	OP000584 3534740168203	344 €HT 588 €HT
16	R200 PROGRESS BUDGET 128 m ² (pack structure et planchers)	OP000585 3534740168210	8590 €HT 18838 €HT
16*	R200 PROGRESS BUDGET 128 m ² (pack plinthes)	OP000587 3534740168227	619 €HT 1059 €HT

COMPOSITION

			ACIER		
			BUDGET 60 m ²	BUDGET 78 m ²	BUDGET 128 m ²
PACK STRUCTURE ET PLANCHERS					
Code	Désignation	Lot	14	15	16
04101002	RCM24F Socle à vis fixe débattement 0,45 m (Ø38 mm)	8	10	10	12
04002009	R1 Cadre de départ en U 1,20 m - acier	4	5	5	6
04002004	R3 Cadre en H 2,00 m - acier	6	7	7	14
04002006	R4 Cadre 2,00 m asymétrique - acier	2	3	3	4
04030054	Échelle acier	2	2	2	3
04010335	R08-CT3000X730 - Plancher d'accès alu-bois - longueur 3,00 m - largeur 0,73 m	2	2	2	3
04010001	RCE300 - Plateau acier crochets sertis - longueur 3,00 m - largeur 0,36 m	10	14	14	26
04005005	RCM30 Diagonale verticale indexée, maille 3,00 x 2,00 m	2	2	2	6
00010550	RCM608 Lisse d'extrémité 0,80 m	8	8	8	12
00010520	RCM630 Lisse latérale 3,00 m	14	18	18	33
PACK PLINTHES					
Code	Désignation	Lot	14*	15*	16*
04010208	PC080 Plinthe acier 0,80 m	4	4	4	6
04010201	PC300 Plinthe acier 3,00 m	6	8	8	15

LOTS R200 PIGNON

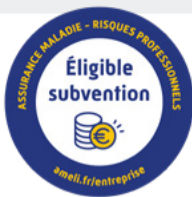

Sauf lots non MDS

PIGNON 68 M²

NOUVEAU

- L : 9,00 m - H : 6,00 m plancher
- Surface de travail 10 x 6 m + pignon 3 x 2 m
- 2 lots de 3 amarrages recommandés ⁽¹⁾
- 1 version : acier



OP000987

+ Plancher de départ sur tous nos lots R200 pour + de confort

PIGNON 88 M²

- L : 9,00 m - H : 8,00 m plancher
- Surface de travail 10 x 8 m + pignon 2 x 4 m
- 2 lots de 3 amarrages recommandés ⁽¹⁾
- 2 versions : aluminium et acier



OP000146

LOT	ACIER	Montage, démontage en sécurité	CODE PROMO Gencod	PRIX PROMO Tarif 2025
1	68 m ² PROGRESS PIGNON + planchers RCE acier + garde-corps lisses		OP000987 3534740179551	5976 €HT 12991 €HT NEW
2	68 m ² PROGRESS PIGNON + planchers R08 alu/bois + garde-corps lisses		OP000988 3534740179568	6259 €HT 13541 €HT NEW
3	68 m ² PROGRESS PIGNON + planchers RCE acier + garde-corps FUSIO	MDS	OP000985 3534740179537	6389 €HT 13830 €HT NEW
4	68 m ² PROGRESS PIGNON + planchers R08 alu/bois + garde-corps FUSIO	MDS	OP000986 3534740179544	6639 €HT 14380 €HT NEW
5	88 m ² PROGRESS PIGNON + planchers RCE acier + garde-corps lisses		OP000146 3534740149660	7704 €HT 17151 €HT
6	88 m ² PROGRESS PIGNON + planchers R08 alu/bois + garde-corps lisses		OP000145 3534740149653	8280 €HT 17921 €HT
7	88 m ² PROGRESS PIGNON + planchers RCE acier + garde-corps FUSIO	MDS	OP000162 3534740150413	9166 €HT 18726 €HT
8	88 m ² PROGRESS PIGNON + planchers R08 alu/bois + garde-corps FUSIO	MDS	OP000148 3534740149684	9406 €HT 19496 €HT
LOT	ALUMINIUM	Montage, démontage en sécurité	CODE PROMO Gencod	PRIX PROMO Tarif 2025
9	88 m ² RECORD PIGNON + planchers R08 alu/bois + garde-corps SECURITUP	MDS	04000357 3534740131863	11470 €HT 25365 €HT
10	88 m ² RECORD PIGNON + planchers tout alu + garde-corps SECURITUP	MDS	04000360 3534740131894	13336 €HT 27816 €HT

⁽¹⁾ Préconisation pour une structure non recouverte

COMPOSITION

Code	Désignation	Lot	ACIER								ALU	
			1	2	3	4	5	6	7	8	9	10
04101003	RCM24 Socle à vis articulé débattement 0,45 m (Ø38 mm)	8	8	8	8	8	8	8	8	8	8	8
04002009	R1 Cadre de départ en U1,20 m - Acier	4	4	4	4	4	4	4	4	-	-	-
04702013	R200 R1 cadre de départ en U1,20 m - Aluminium	-	-	-	-	-	-	-	-	4	4	4
04002004	R3 Cadre en H 2,00m Acier	10	10	10	10	14	14	14	14	-	-	-
04702010	R200 R3 Cadre en H 2,00 m Aluminium	-	-	-	-	-	-	-	-	14	14	14
04204043	Longeron forte charge 3,00 m	8	8	2	2	10	10	2	2	2	2	2
00010520	RCM630 Lisse latérale 3,00 m	17	17	3	3	24	24	4	4	4	4	4
04005005	RCM30 Diagonale verticale indexée, maille 3 x 2 m	5	5	2	2	7	7	2	2	7	7	7
00015104	RCM180 Etrier à pion	-	-	-	-	-	-	-	-	2	2	2
04004031	FUSIO300 Garde-corps diagonalisant montage / démontage en sécurité 1 personne	-	-	7	7	-	-	10	10	-	-	-
04004006	GCMS080 Garde-corps monobloc sécurité avec plinthe	-	-	4	4	-	-	8	8	-	-	-
04704003	SECURITUP ALUMINIUM Garde-corps monobloc sécurité avec plinthe 3,00m	-	-	-	-	-	-	-	-	10	10	10
00010550	RCM608 Lisse d'extrémité 0,80m	12	12	4	4	16	16	-	-	16	16	16
04010351	Plancher R08-A3000X730 Tout Aluminium	-	-	-	-	-	-	-	-	-	7	7
04010359	Plancher R08-AT3000X730 Tout Aluminium	-	-	-	-	-	-	-	-	-	4	4
04010320	Plancher R08-C3000X730	-	5	-	5	-	7	-	7	7	-	-
04010335	Plancher R08-CT3000X730	3	3	3	3	4	4	4	4	4	-	-
04010001	RCE300 - Plateau acier 3,00m largeur 0,36	10	-	10	-	14	-	14	-	-	-	-
02460034	RCM48 Échelle Aluminium	3	3	3	3	4	4	4	4	4	4	4
04010201	PC300 Plinthe acier 3,00m	7	7	7	7	10	10	10	10	-	-	-
04010208	PC080 Plinthe acier 0,80m	6	6	2	2	8	8	-	-	8	8	8
00035775	Notice R200	1	1	1	1	1	1	1	1	1	1	1

RECORD 88 M²



PERMIS B



Remorque Record vendue vide

ROLLER 160 M²



NOUVEAU

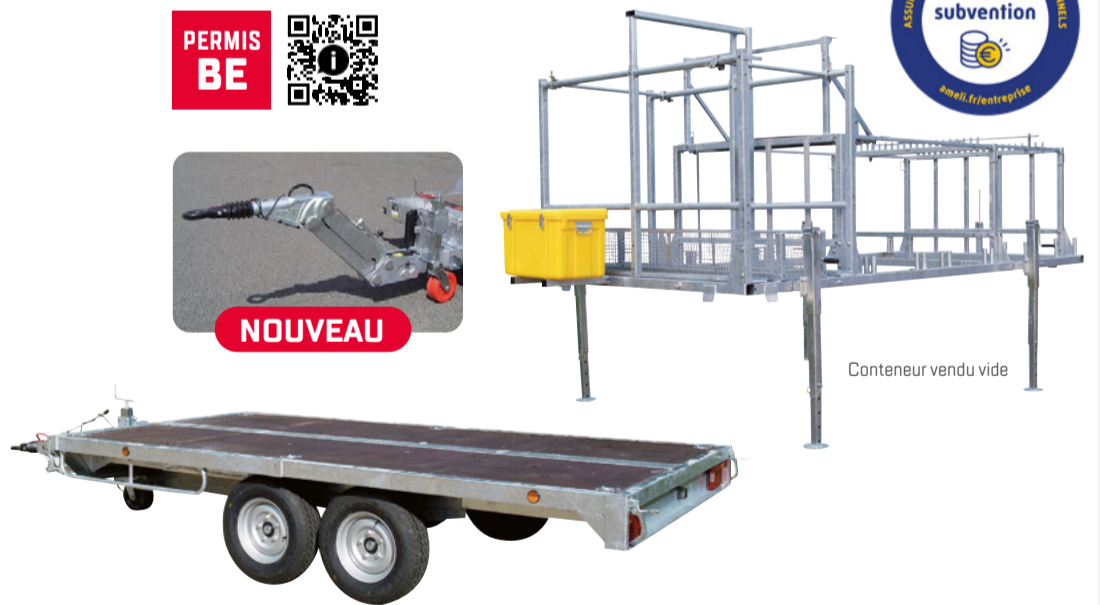

Remorque Roller

Conteneur vendu vide

REMORQUES R200

REMORQUE RECORD pour R200 PROGRESS 88 m ² (1,5T en charge) : disponible mars 2025	OP000978 3534740179489	6405 €HT 10034 €HT NEW
REMORQUE RECORD pour R200 PROGRESS 88 m ²	OP000388 3534740158167	6405 €HT 10034 €HT
REMORQUE RECORD pour R200 RECORD 88 m ²	04000358 3534740131870	6405 €HT 10034 €HT
REMORQUE ROLLER pour R200 PROGRESS 160 m ² timon articulé + conteneur 160 m ³ garde-corps + roue de secours et antivol (3,2T en charge)	OP000610 3534740169859	15889 €HT 24660 €HT
REMORQUE ROLLER pour R200 PROGRESS 160 m ² timon articulé compensateur d'effort avec manivelle de réglage + conteneur 160 m ³ garde-corps + roue de secours et antivol (3,2T en charge)	OP000979 3534740179476	15999 €HT 24862 €HT NEW
JEU DE RIDELLES pour remorques 160 m ²	OP000612 3534740169873	2242 €HT 3537 €HT

L'immatriculation est à la charge du client après achat.



IMMATRICULATION ET CARTE GRISE OFFERTES SUR DEMANDE

**ÉCHELLES +
PLANCHERS
À TRAPPE R08-CT**



**PLANCHERS
R08**



**PLANCHERS
RCE 300**

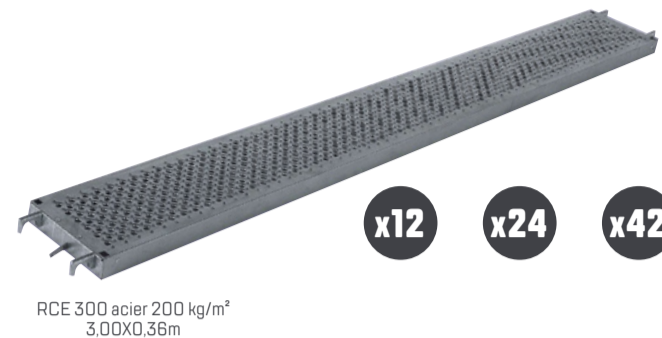

	CODE PROMO Gencod	PRIX PROMO Tarif 2025
LOT de 3 planchers à trappe R08-CT ALU BOIS 3,00 x 0,73 m + 3 échelles aluminium	OP000456 3534740160641	1220 €HT 2736 €HT
LOT de 3 planchers R08 ALU BOIS 3,00 x 0,73 m	OP000391 3534740159690	816 €HT 1656 €HT
LOT de 12 planchers RCE 300 200 kg/m ² 3,00 x 0,36 m	OP000167 3534740150420	1354 €HT 2662 €HT
LOT de 24 planchers RCE 300 200 kg/m ² 3,00 x 0,36 m	OP000168 3534740150437	2539 €HT 5304 €HT
LOT de 42 planchers RCE 300 200 kg/m ² 3,00 x 0,36 m	OP000169 3534740150444	4032 €HT 9282 €HT

**LOT DE 3 AMARRAGES
ANNEAU**



Réf.	AMARRAGE ANNEAU	Qté
04230033	Sachet de 50 chevilles plastique GD 14/70	1
04230034	Sachet de 25 pitons métalliques GRS 12/90	1
04230054	BA180 Barre à crochet 1,80m, fixation directe sur anneau	3
00081440	RCM230 Collier orientable EN74	6

**LOT DE 3 AMARRAGES
VÉRIN DE FENÊTRE**



Réf.	AMARRAGE VÉRIN DE FENÊTRE	Qté
04230050	Vérin d'amarrage fenêtre réglable 0,80 à 1,30m	3
00010675	RCM22 Barre d'amarrage à collier 1,50m	3
00081440	RCM230 Collier orientable EN74	6

	CODE PROMO Gencod	PRIX PROMO Tarif 2025
LOT de 3 amarrages «anneau» (avec GD et GRS)	04000162 3534740118994	434 €HT 941 €HT
LOT de 3 amarrages «vérin de fenêtre»	04000163 3534740119007	538 €HT 1131 €HT

**GARDE-CORPS FUSIO
3,00 M**

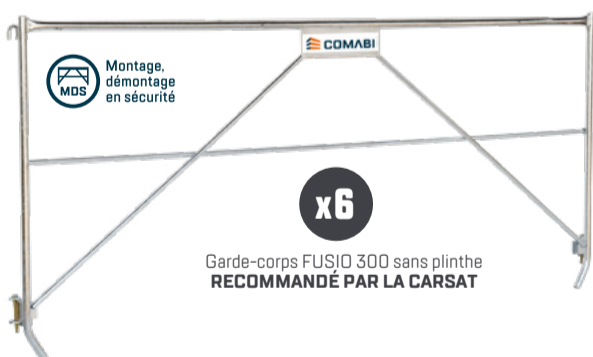

**CADRES R3
2,00 M ACIER**



**CADRES R3
2,00 M ALU**



**SOCLES
RCM23**

• Hauteur débattement 45 cm



**STABILISATEURS S1 ET COMPLÉMENTS
POUR STABILISATEUR S2**



Sur structure R200 :

- Le stabilisateur S1 ne doit pas être utilisé sur une hauteur plancher > 5,50 m.
- Le stabilisateur S2 ne doit pas être utilisé sur une hauteur plancher > 7,50 m.

STABILISATEUR S2 = 1 stabilisateur S1 + 1 complément pour stabilisateur S2

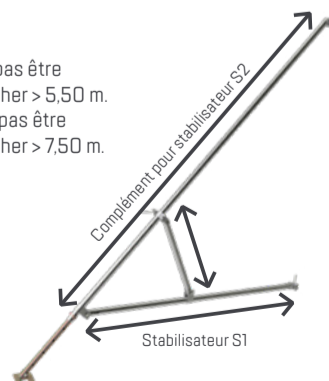
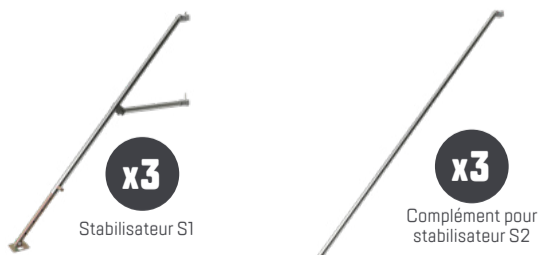

	CODE PROMO Gencod	PRIX PROMO Tarif 2025
LOT de 6 garde-corps acier FUSIO 300 sans plinthe	OP000390 3534740159683	1085 €HT 2112 €HT
LOT de 10 cadres acier R3	OP000301 3534740154534	1142 €HT 2280 €HT
LOT de 6 cadres aluminium R3	OP000720 3534740174686	1319 €HT 2760 €HT
LOT de 10 socles acier RCM23	OP000963 3534740178042	386 €HT 980 €HT
LOT de 3 stabilisateurs acier S1	OP000663 3534740172828	425 €HT 735 €HT
LOT de 3 compléments acier stabilisateurs S2	OP000664 3534740172835	296 €HT 567 €HT

PONTS COUVREUR



- Modèles de pont couvreur 4 m disponibles sur demande
- Unique sur le marché
- Montage 100 % sécurisé

MODÈLE 6M

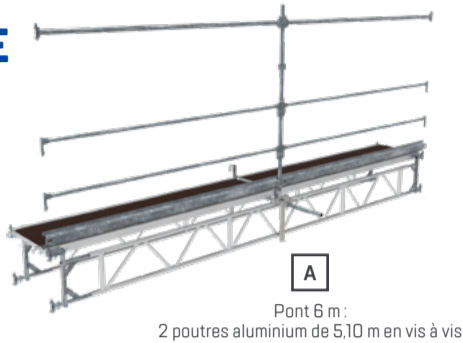

A
Pont 6 m :
2 poutres aluminium de 5,10 m en vis à vis

MODÈLE 9M

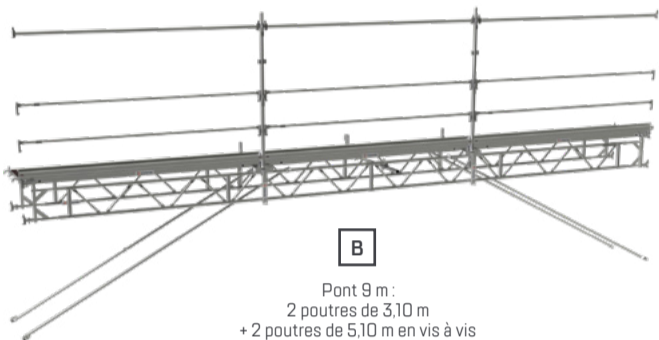

B
Pont 9 m :
2 poutres de 3,10 m
+ 2 poutres de 5,10 m en vis à vis

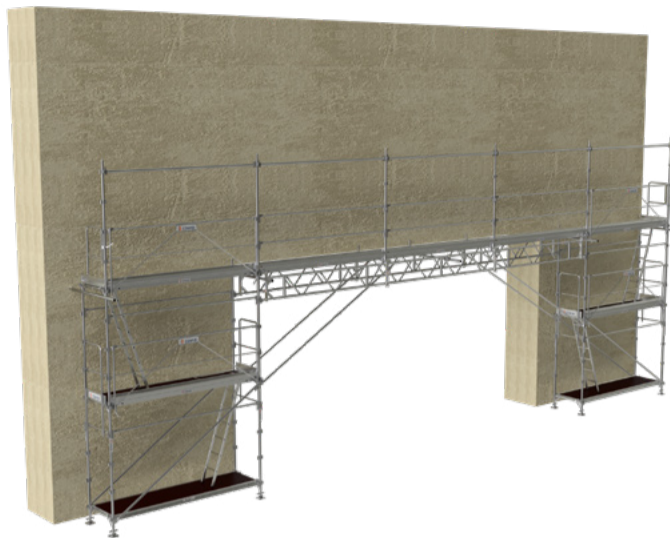

DÉPORTS COUVREUR

- 0,80 m, 1,00 m ou 1,50 m de déport en toute sécurité

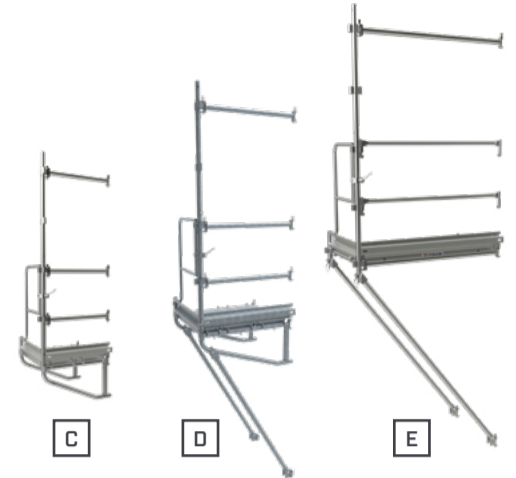

COMPOSITION PONTS

CODE	DÉSIGNATION	A	B
00010520	RCM630 Lisse latérale 3,00m	4	6
00015162	MH2400 Diagonale horizontale à collier maille	-	4
00080450	RCM12 Goupille D12 mm	2	4
00081440	RCM230 Collier orientable EN74	2	2
04002007	R5 Montant 1,00m Acier	2	4
04010201	PC300 Plinthe acier 3,00 m	2	3
04010320	Plancher R08-C3000X730	2	3
04099142	Demi Chariot Roulant (à utiliser par 2 avec un longeron standard)	2	4
04099143	Garde-corps d'extrémité 60cm passage sous gouttières	3	4
04099146	Barre-col-de-cygne	1	1
04099147	Boîte de 25 goupilles axes 12mm + bêta	1	2
04099148	Liaison Poutre Aluminium sur douilles réversibles	4	4
04204011	MS300 Longeron 3,00m	2	3
04204007	MS080 Longeron 0,80m	1	2
06001001	Poutre Aluminium 3,10mxH=0,40 m	-	2
06001003	Poutre Aluminium 5,10mxH=0,40 m	2	2
06001007	Ensemble 4 manchons de liaison poutre Aluminium	-	1
00035354	Notice R200 Couvreur	1	1
00034413	Notice R200	1	1

COMPOSITION DÉPORTS

CODE	DÉSIGNATION	C	D	E
00080450	RCM12 Goupille D12 mm	2	2	1
04002007	R5 Montant 1,00m Acier	2	2	1
04010208	PC080 Plinthe acier 0,80 m	2	1	1
04010205	PC150 Plinthe acier 1,50 m	-	-	1
04010207	PC100 Plinthe acier 1,00 m	-	1	-
04099143	Garde-corps d'extrémité 0,60 m passage sous gouttières	1	1	1
04204007	MS080 Longeron 0,80 m	3	-	-
04204006	MS100 Longeron 1,00 m	-	3	-
04204008	SOLIDIUM MS150 Longeron 1,50 m	-	-	3
04210117	Plateau R14AC-CS-0M80X0M18	-	1	-
04210110	Plateau R14AC-CS-0M80X0M36	2	2	-
04210109	Plateau R14AC-CS-1M00X0M36	-	-	-
04210107	Plateau R14AC-CS-1M50X0M36	-	-	2
04220018	Console C08-EMD-800	2	-	-
04220019	Console avec manchon C08-EMD1000 + douilles 1,00 m	-	2	-
00010915	RCM615 Lisse latérale 1,50 m	-	-	2
00033551	Jambe de force montée couvreur	-	-	2
04230031	M58 Jambe de force	-	2	-
00033552	Cadre spécial couvreur	-	-	1

LOT	ACIER	CODE PROMO Gencod	PRIX PROMO Tarif 2025
A	PONT COUVREUR 6,00 m linéaire complet	OP000130 3534740148571	3409 €HT 6553 €HT
B	PONT COUVREUR 9,00 m linéaire complet	OP000092 3534740143200	5684 €HT 10550 €HT
C	R200 PROGRESS DÉPORT COUVREUR 0,80 m complet	OP000093 3534740143217	637 €HT 1336 €HT
D	R200 PROGRESS DÉPORT COUVREUR 1,00 m complet	OP000801 3534740175577	800 €HT 1972 €HT
E	R200 PROGRESS DÉPORT COUVREUR 1,50 m complet	04000424 3534740136660	960 €HT 1700 €HT

PROTECTIONS ANTI-CHUTES UNYC®



KIT BUDGET +



- 1 corde gainée tressée 10 m
- 1 antichute bloqueur coulissant
- 2 mousquetons acier
- 1 sac 20 L



1 harnais BUDGET

TAILLE	CODE PROMO Gencod	PRIX PROMO Tarif 2025
S-M-L-XL	OP000824 3178740244361	192 €HT 326 €HT + x1
XXL-XXXL	OP000825 3178740244378	189 €HT 322 €HT + x1

Kits vendus sans le buste.

KIT ESSENTIAL DUO



- 1 longe corde double 1 m avec absorbeur d'énergie
- 1 sac 20 L



1 harnais ESSENTIAL

TAILLE	CODE PROMO Gencod	PRIX PROMO Tarif 2025
S-M-L-XL	OP000826 3178740244385	183 €HT 307 €HT + x1
XXL-XXXL	OP000827 3178740244392	181 €HT 304 €HT + x1

Kits vendus sans le buste.

KIT COMFORT



- 1 corde gainée tressée 10 m
- 1 antichute bloqueur coulissant
- 2 mousquetons acier
- 1 anneau d'ancrage 1 m
- 1 sac 20 L



1 harnais COMFORT

TAILLE	CODE PROMO Gencod	PRIX PROMO Tarif 2025
S-M-L-XL	OP000828 3178740244408	232 €HT 380 €HT + x1
XXL-XXXL	OP000829 3178740244415	232 €HT 380 €HT + x1

Kits vendus sans le buste.

SAC ÉTANCHE 30 L

Sac de transport étanche PVC permettant le rangement de produits anti-chute. Très confortable grâce aux bretelles avec mousse renforcée, dos en mousse et filet anti-transpiration. Ce sac à dos 30L permet de transporter vos affaires et de les protéger des projections d'eau ou lors de brèves immersions. Idéal pour les pratiques de loisirs de plein air.



QUANTITÉ	CODE PROMO Gencod	PRIX PROMO Tarif 2025
x1	OP000860 3178740244729	38 €HT 102 €HT
x2	OP000861 3178740244736	72 €HT 204 €HT
x5	OP000862 3178740244743	173 €HT 519 €HT

M49 SPÉCIAL MAÇON

PRIMO 60 M²

- L : 9,00 m - H : 4,00 m plancher
- Surface de travail 10 x 6 m
- 2 lots de 3 amarrages recommandés ⁽¹⁾

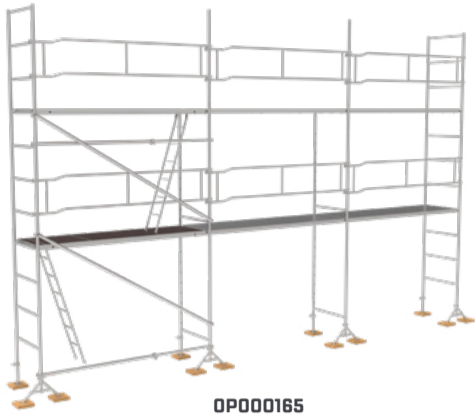

OP000165

MEDIUM 80 M²

- L : 9,00 m - H : 6,00 m plancher
- Surface de travail 10 x 8 m
- 2 lots de 3 amarrages recommandés ⁽¹⁾

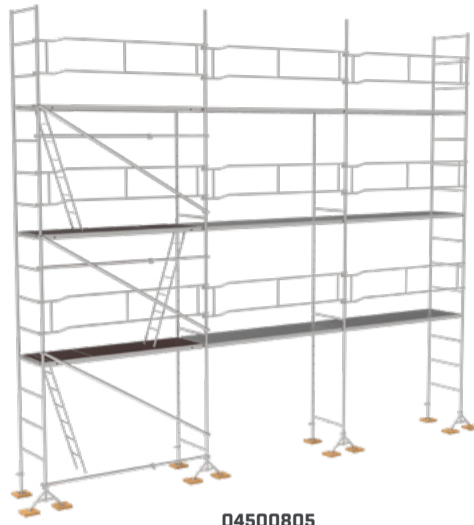

04500805

MASTER 104 M²

- L : 12,00 m - H : 6,00 m plancher
- Surface de travail 13 x 8 m
- 3 lots de 3 amarrages recommandés ⁽¹⁾

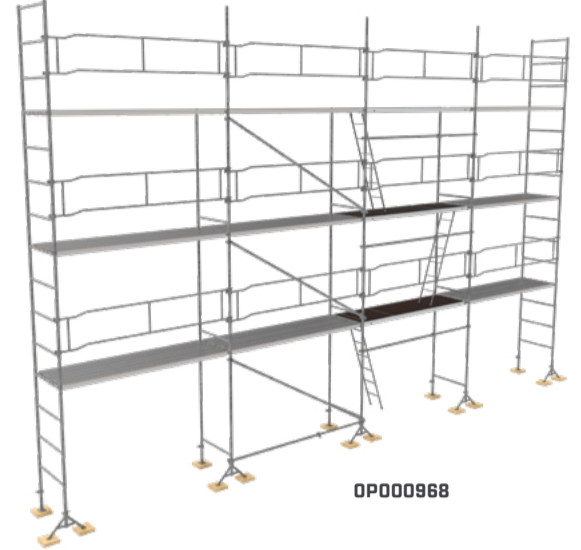

OP000968

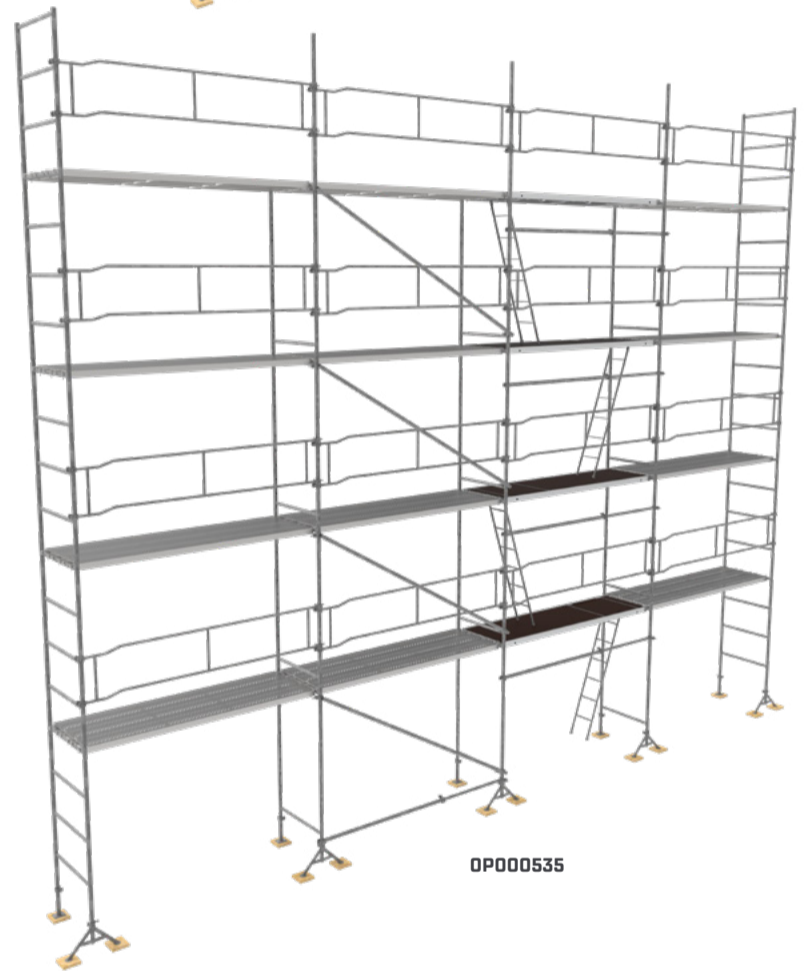

OP000535

EXPERT 130 M²

- L : 12,00 m - H : 8,00 m plancher
- Surface de travail 13 x 10 m
- 3 lots de 3 amarrages recommandés ⁽¹⁾

LOT	ACIER	CODE PROMO Gencod	PRIX PROMO Tarif 2025
1	60 m ² PRIMO structure seule	OP000164 3534740150215	2099 €HT 4122 €HT
2	60 m ² PRIMO PLUS structure + planchers acier + accès	OP000165 3534740150222	4055 €HT 8322 €HT
3	80 m ² MEDIUM structure seule	04500804 3534740132266	2947 €HT 5680 €HT
4	80 m ² MEDIUM PLUS structure + planchers acier + accès	04500805 3534740132273	5726 €HT 11980 €HT
5	104 m ² MASTER structure seule	OP000967 3534740178080	3410 €HT 7076 €HT
6	104 m ² MASTER PLUS structure + planchers acier + accès	OP000968 3534740178097	7520 €HT 15667 €HT
7	130 m ² EXPERT structure seule	OP000547 3534740167107	4319 €HT 8931 €HT
8	130 m ² EXPERT PLUS structure + planchers acier + accès	OP000535 3534740167008	9313 €HT 20435 €HT



⁽¹⁾ Préconisation pour une structure non recouverte

COMPOSITION

Code	Désignation	Lot	ACIER							
			PRIMO 60 m ²		MEDIUM 80 m ²		MASTER 104 m ²		EXPERT 130 m ²	
04501004	M49 Pied de départ	4	4	4	4	4	5	5	5	5
04501005	M49 Pied triangle bas	4	4	4	4	4	5	5	5	5
04502001	M49 Cadre à passage, montants percés	4	4	6	6	9	9	12	12	12
04502005	M49 Cadre 2,00m - 4 barreaux	4	4	6	6	6	6	8	8	8
04502004	M49 Cadre 1,50m - 3 barreaux	2	2	2	2	2	2	2	2	2
04503001	M49 Poteau 1,60m (pour dernier niveau)	2	2	2	2	3	3	3	3	3
04504006	M49 Lisse réglable à clavier 2,00m à 3,50m	-	2	-	3	-	4	-	5	-
04504001	M49 garde-corps monobloc haut 0,50m sans plinthe - 3,00m	6	6	9	9	12	12	16	16	16
04305003	DVC - 3,00 x 2,00m Diag. verticale à clavier sur montant D48,3 mm	2	2	3	3	3	3	4	4	4
04210024	SCE300 Plancher acier avec poignées largeur 0,30m	-	12	-	18	-	27	-	36	-
04010334	Plancher RO8-CT 3000X850 sans échelle	-	2	-	3	-	3	-	4	-
04030054	Échelle acier	-	2	-	3	-	3	-	4	-
00034237	Notice M49	1	1	1	1	1	1	1	1	1

Conformes au décret 2004-924 : avec garde-corps sécurité (GCMS) ou lisses + pack plinthes (à rajouter en complément du lot promo), le certificat de conformité est émis sous réserve de la vérification de la nomenclature achetée. Pour être conforme à la réglementation en vigueur se référer à la notice de montage du produit concerné.

CADRES 2,00M



x6

GARDE-CORPS MONOBLOCS



x6

PLANCHERS + ÉCHELLES

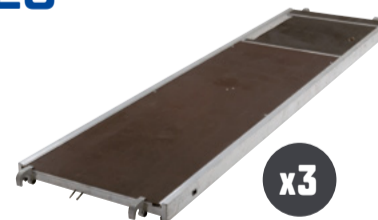

x3

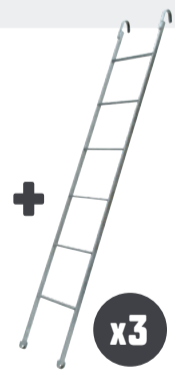

x3

Plancher à trappe RO8-CT ALU BOIS 3,00x0,85 m

Échelle acier

PLANCHERS SCE 3,00 M

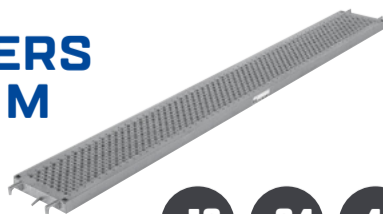

x12

x24

x42

CADRES À PASSAGE MONTANTS PERCÉS



x6

	CODE PROMO Gencod	PRIX PROMO Tarif 2025
Lot de 6 cadres à passage montants percés	OP000360 3534740157696	583 €HT 996 €HT
Lot de 6 cadres 2 m 4 barreaux	OP000522 3534740166872	702 €HT 1176 €HT
Lot de 6 garde-corps monoblocs hauteur 0,50 m	OP000359 3534740157689	715 €HT 1306 €HT
Lot de 3 planchers à trappe RO8CT ALU BOIS 3,00x0,85 m + 3 échelles acier	OP000023 3534740139555	1389 €HT 2034 €HT
Lot de 12 planchers SCE 300 300 kg/m ² 3,00x0,30 m	OP000149 3534740149691	110 €HT 2244 €HT
Lot de 24 planchers SCE 300 300 kg/m ² 3,00x0,30 m	OP000150 3534740149707	2040 €HT 4408 €HT
Lot de 42 planchers SCE 300 300 kg/m ² 3,00x0,30 m	OP000151 3534740149714	3290 €HT 7854 €HT

STARTEO

Norme EN 1004-1



Ultra compact +

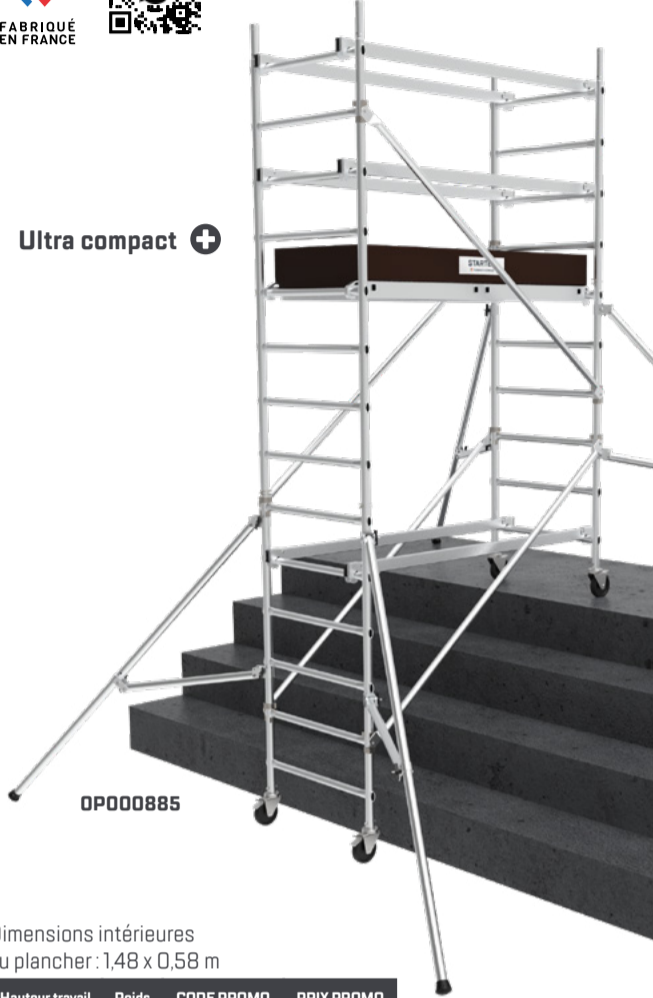

OP000885

Dimensions intérieures du plancher : 1,48 x 0,58 m

Hauteur travail maxi (m)	Poids (kg)	CODE PROMO Gencod	PRIX PROMO Tarif 2025
3,60	52,9	OP000884 3178740246815	889€HT 1667€HT
4,60	60,7	OP000885 3178740246822	930€HT 1745€HT

RUNNER

Norme EN 1004-1



Extrêmement mobile +



OP000754

Dimensions intérieures du plancher : 1,48 x 0,58 m

Hauteur travail maxi (m)	Poids (kg)	CODE PROMO Gencod	PRIX PROMO Tarif 2025
3,60	56,9	OP000753 3178740237608	1009€HT 1986€HT
4,60	64,7	OP000874 3178740245894	1064€HT 2076€HT
5,60	93,1	OP000754 3178740237615	1533€HT 2988€HT
6,60	98,4	OP000875 3178740245900	1634€HT 3187€HT
7,60	126,8	OP000755 3178740237622	1906€HT 3771€HT

INSIDER



Spécial espace exigé +



OP000776

Dimensions intérieures du plancher : 1,10 x 0,50 m

Hauteur travail maxi (m)	Poids (kg)	CODE PROMO Gencod	PRIX PROMO Tarif 2025
4,85	58,7	OP000774 3178740237813	1374€HT 2644€HT
5,85	81,3	OP000775 3178740237820	1872€HT 3683€HT
6,85	85,4	OP000776 3178740237837	1972€HT 3787€HT

TOTEM

Norme EN 1004-1



Organisme certificateur : **AFNOR Certification**, 11, rue Francis de Pressensé, F-93571 La Plaine Saint Denis Cedex
Référentiel de certification : NF équipements de chantier (NF096) disponible sur www.marque-nf.com La marque NF certifie la conformité à la norme EN 1004-1 et au référentiel NF096.

Dimensions intérieures du plancher :

- 1,70 x 0,65 m (modèles 180)
- 2,40 x 0,65 m (modèles 250)

Modèles toutes options +



BOX

TOTEM LINE

Hauteur travail maxi (m)	Poids (kg)	CODE PROMO Gencod	PRIX PROMO Tarif 2025
TOTEM LINE 180 4,85 m travail	79,0	OP000762 3178740237691	1641€HT 3316€HT
TOTEM LINE 180 6,85 m travail	115,5	OP000763 3178740237707	2401€HT 4882€HT
TOTEM LINE 180 7,85 m travail	148,6	OP000764 3178740237714	3032€HT 6053€HT
TOTEM LINE 250 4,85 m travail	91,2	OP000768 3178740237752	2024€HT 4041€HT
TOTEM LINE 250 6,85 m travail	136,4	OP000769 3178740237769	2960€HT 5924€HT
TOTEM LINE 250 7,85 m travail	176,2	OP000770 3178740237776	3772€HT 7548€HT



LINE

TOTEM BOX

Hauteur travail maxi (m)	Poids (kg)	CODE PROMO Gencod	PRIX PROMO Tarif 2025
TOTEM BOX 180 4,85 m travail	79,0	OP000765 3178740237721	1754€HT 3503€HT
TOTEM BOX 180 6,85 m travail	115,0	OP000766 3178740237738	2613€HT 5215€HT
TOTEM BOX 180 7,85 m travail	145,8	OP000767 3178740237745	3302€HT 6626€HT
TOTEM BOX 250 4,85 m travail	90,4	OP000771 3178740237783	1987€HT 3983€HT
TOTEM BOX 250 6,85 m travail	135,1	OP000772 3178740237790	2929€HT 5872€HT
TOTEM BOX 250 7,85 m travail	174,4	OP000773 3178740237806	3705€HT 7403€HT



OP000769

OP000773

CROSS

Norme EN 1004-1

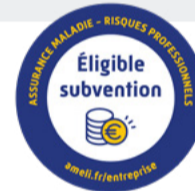

Dimensions intérieures du plancher :

- 1,70 x 0,65 m (modèle 180)
- 2,40 x 0,65 m (modèle 250)

Polyvalents +



180



250

CROSS 180

Hauteur travail maxi (m)	Poids (kg)	CODE PROMO Gencod	PRIX PROMO Tarif 2025
3,85	76,0	OP000756 3178740237639	1413€HT 2537€HT
5,85	108,4	OP000757 3178740237646	2017€HT 3883€HT
7,85	144,1	OP000758 3178740237653	2887€HT 5563€HT

CROSS 250

Hauteur travail maxi (m)	Poids (kg)	CODE PROMO Gencod	PRIX PROMO Tarif 2025
3,85	84,0	OP000759 3178740237660	1675€HT 3189€HT
5,85	134,4	OP000760 3178740237677	2572€HT 4958€HT
7,85	181,5	OP000761 3178740237684	3379€HT 6383€HT

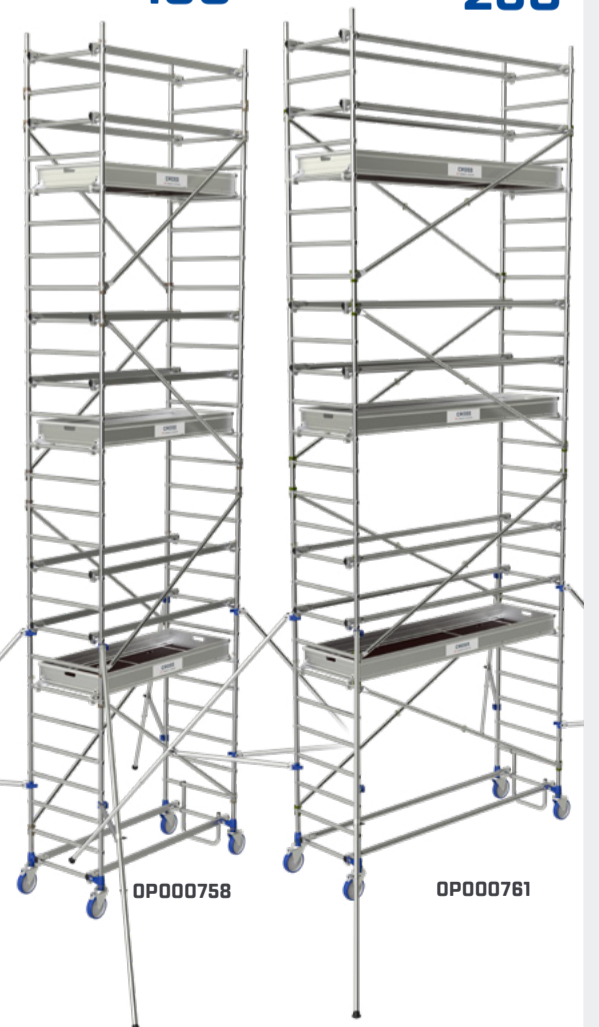

OP000758

OP000761

NEOLIUM EVO NOUVEAU

Norme EN 1004-1



Montage en solo +

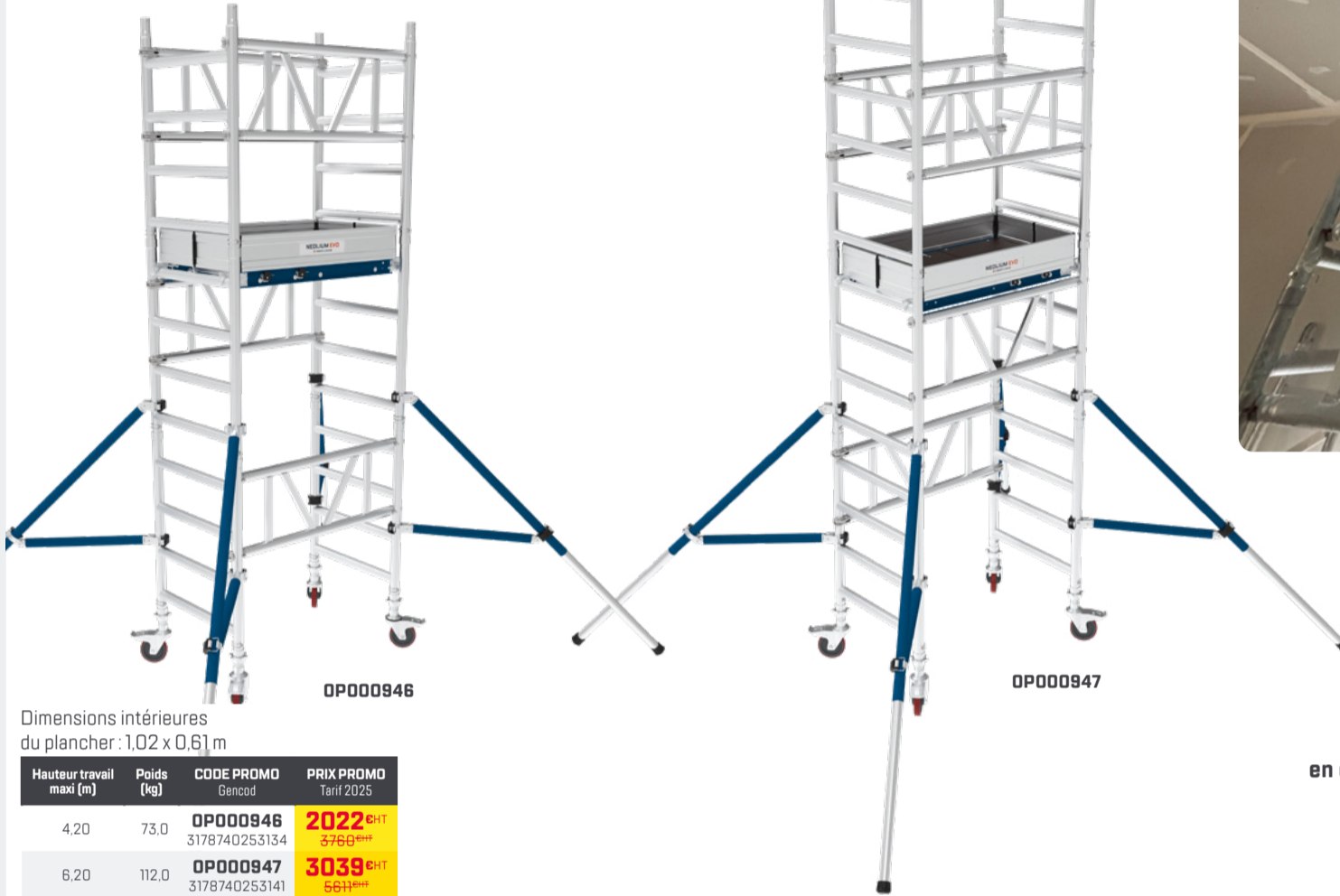

Se transforme en chariot mobile +

Dimensions intérieures du plancher : 1,02 x 0,61 m

Hauteur travail maxi (m)	Poids (kg)	CODE PROMO Gencod	PRIX PROMO Tarif 2025
4,20	73,0	OP000946 3178740253134	2022€ HT 3760€ HT
6,20	112,0	OP000947 3178740253141	3039€ HT 5611€ HT

NEOLIUM 400 LINE

Norme EN 1004-1



Tour aluminium soudé ultra robuste +



Dimensions intérieures du plancher : 1,90 x 1,32 m

Hauteur travail maxi (m)	Poids (kg)	CODE PROMO Gencod	PRIX PROMO Tarif 2025
6,00	215,0	OP000579 3534740167749	4396€ HT 7390€ HT



Bénéficiez jusqu'à 25 000€ de subvention pour l'achat de nos produits éligibles.

Montant de la subvention : **50% du montant HT** des sommes engagées pour les équipements. Le montant minimum de subvention est de 1 000 €. Plafond à 25 000 € (plusieurs demandes possibles).

Vos clients peuvent aussi se renseigner sur les critères d'éligibilité sur le site [Ameli](https://www.ameli.fr/entreprise) ou auprès de leur Caisse d'Assurance maladie. Demande de réservation via [net-entreprises.fr](https://www.net-entreprises.fr)

JUNIOR 200



Spécial finition +

OP000369

Dimensions intérieures
du plancher : 1,86 x 0,51 m

Hauteur travail maxi (m)	Poids (kg)	CODE PROMO Gencod	PRIX PROMO Tarif 2025
3.80	88	OP000368 3534740157771	1097€HT 2116€HT
4.80	101	OP000369 3534740157788	1357€HT 2612€HT
6.80	181	OP000370 3534740157795	2210€HT 4324€HT

TOUR GENERIS 450

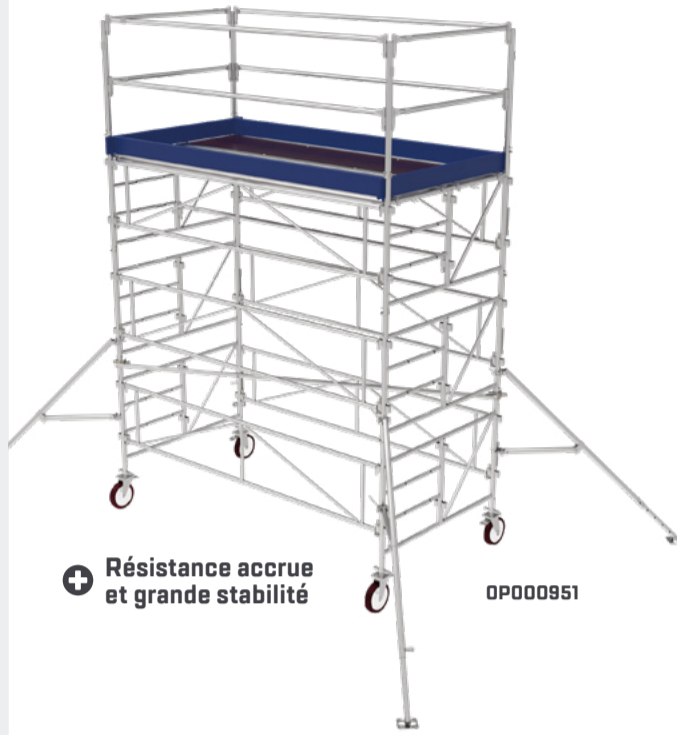

+ Résistance accrue et grande stabilité

OP000951

Dimensions intérieures
du plancher : 2,90 x 1,42 m

Hauteur travail maxi (m)	Poids (kg)	CODE PROMO Gencod	PRIX PROMO Tarif 2025
4.30	292	OP000952 3534740177854	3332€HT 6404€HT
5.30	353	OP000951 3534740177861	3722€HT 7158€HT
6.30	465	OP000952 3534740177878	4817€HT 9266€HT
8.30	647	OP000953 3534740177885	6463€HT 12430€HT

TOUR GENERIS 900



+ Plate-forme de travail ultra-large
+ Auto-stable jusqu'à 8,30 m travail

OP000204

Dimensions intérieures
du plancher : 2,90 x 2,90 m

Hauteur travail maxi (m)	Poids (kg)	CODE PROMO Gencod	PRIX PROMO Tarif 2025
4.30	347	OP000363 3534740157726	3868€HT 7752€HT
5.30	422	04100050 3534740153766	4338€HT 8254€HT
6.30	547	OP000204 3534740153667	5666€HT 11157€HT
8.30	755	OP000489 3534740163543	7599€HT 14764€HT

GENERIS 300

Norme EN 1004-1



Très compact +

OP000012

Dimensions intérieures
du plancher : 1,40 x 0,58 m

Hauteur travail maxi (m)	Poids (kg)	CODE PROMO Gencod	PRIX PROMO Tarif 2025
5.00	103	OP000054 3534740140544	1434€HT 2548€HT
6.50	150.4	OP000012 3534740139449	2081€HT 3996€HT

Organisme certificateur: **AFNOR Certification**,
11, rue Francis de Pressensé, F-93571 La Plaine Saint Denis Cedex
Référentiel de certification: NF équipements de chantier (NF096)
disponible sur www.marque-nf.com La marque NF certifie la conformité à la norme EN 1004-1 et au référentiel NF096.

GENERIS 750 / 950

Norme EN 1004-1

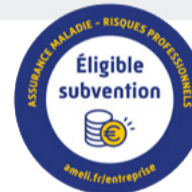

* Sauf GENERIS 750 7,20 m - 9,30 m et GENERIS 950 7,20 m - 9,30 m.
Tous les modèles sont évolutif 12 m avec rehausses optionnelles.

750



+ Résistant

OP000730

Dimensions intérieures
du plancher : 1,90 x 0,65 m

GENERIS 750

Hauteur travail maxi (m)	Poids (kg)	CODE PROMO Gencod	PRIX PROMO Tarif 2025
4.80	179	OP000730 3534740175348	1871€HT 3621€HT
7.20	265	OP000781 3534740175393	2726€HT
9.30	365	OP000731 3534740175355	3714€HT
10.80	430	OP000876 3534740177120	4834€HT 9386€HT

950



Ultra stable +

OP000782

Dimensions intérieures
du plancher : 2,90 x 0,65 m

GENERIS 950

Hauteur travail maxi (m)	Poids (kg)	CODE PROMO Gencod	PRIX PROMO Tarif 2025
4.80	208	OP000732 3534740175382	2319€HT 4324€HT
7.20	340	OP000782 3534740175409	3657€HT
9.30	429	OP000733 3534740175379	4286€HT
10.80	508	OP000877 3534740177137	5855€HT 10931€HT

X'TOWER

Norme EN 1004-1



- Montage en 3 minutes
- Télescopique



1 KIT EMBARQ OFFERT

pour faciliter le rangement du X'TOWER dans le véhicule

Dimensions intérieures du plancher : 1,55 x 0,60 m

Hauteur travail maxi (m)	Poids (kg)	CODE PROMO Gencod	PRIX PROMO Tarif 2025	
4,00	74,2	0P000518 3178740197278	2611€HT 5219€HT	+1 KIT EMBARQ OFFERT
4,80	65	0P000549 3178740197964	2978€HT 5961€HT	+1 KIT EMBARQ OFFERT

0P000549



Z'TOWER

Norme EN 1004-1



- Montage en 2 minutes
- Télescopique



Dimensions intérieures du plancher : 1,30 x 0,55 m

Désignation	Hauteur travail maxi (m)	Poids (kg)	CODE PROMO Gencod	PRIX PROMO Tarif 2025
Z'Tower	3,80	57	0P000888 3178740248284	1862€HT 3998€HT
Lot Z'Tower + kit dechargement	3,80	59	0P000991 3178740261313	2038€HT 3782€HT

ACCESSOIRES

AIDE AU CHARGEMENT Z'TOWER



CODE PROMO Gencod	Poids (kg)	PRIX PROMO Tarif 2025
0P000845 3178740253127	2,71	176€HT 484€HT

PORTE-OUTILS SPÉCIAL ÉCHAFAUDAGES ROULANTS

Non compatible avec le Goliath, X'Tower et tours Generis



CODE PROMO Gencod	Poids (kg)	PRIX PROMO Tarif 2025
0P000881 3178740245948	0,2	32€HT 66€HT

ÉCHELLE D'ACCÈS DALLE



Portillon et plate-forme repliables +



	Hauteur accès maxi (m)	Poids (kg)	CODE PROMO Gencod	PRIX PROMO Tarif 2025
6+4 marches	1,30 /2,00	20,6	OP000750 3178740237578	1164 €HT 2186 €HT
8+7 marches	1,76 /2,92	24,7	OP000751 3178740237585	1300 €HT 2438 €HT
12+12 marches	2,69 /4,77	32,1	OP000752 3178740237592	1524 €HT 2832 €HT

OP000752



ÉCHELLE DE FOUILLE



	Hauteur accès maxi (m)	Poids (kg)	CODE PROMO Gencod	PRIX PROMO Tarif 2025
6+4 marches	1,00 /1,95	21,2	OP000747 3178740237547	1045 €HT 1887 €HT
8+7 marches	1,47 /2,88	25,2	OP000748 3178740237554	1173 €HT 2217 €HT
12+12 marches	2,39 /4,73	32,6	OP000749 3178740237561	1374 €HT 2574 €HT

OP000749



**TOP #1
AXESS**

SÉLECTION BTP

PASSERELLE BANCHE



Grutable +



OP000222

Dimensions intérieures
du plancher: 1,22 x 0,43 m

	Hauteur travail maxi (m)	Poids (kg)	CODE PROMO Gencod	PRIX PROMO Tarif 2025
4 marches	2,83	37	OP000222 3178740148515	1489 €HT 2923 €HT
5 marches	3,05	42	OP000223 3178740148522	1521 €HT 3000 €HT
7 marches	3,48	20	OP000224 3178740148539	1775 €HT 3288 €HT

GOLIATH



L'ultra robuste +



OP000596

Dimensions intérieures
du plancher: 1,10 x 0,60 m

	Hauteur travail maxi (m)	Poids (kg)	CODE PROMO Gencod	PRIX PROMO Tarif 2025
	3,00	77	OP000595 3534740168982	1031 €HT 1788 €HT
	3,90	95	OP000596 3534740168999	1212 €HT 2099 €HT

PREMUR



Permet un amarrage
sur les murs ou banches +



OP000225

Décalage de niveau 160 mm +



1 SAC ÉTANCHE 30L OFFERT

	Hauteur replié (m)	Hauteur déployé (m)	Hauteur accès maxi (m)	Poids (kg)	CODE PROMO Gencod	PRIX PROMO Tarif 2025
	2,89	3,48	4,64	23	OP000225 3178740148546	1097 €HT 2326 €HT

ÉCHELLE D'ACCÈS CAMION



Pour accéder aux
plateaux des camions
de 1,25 à 1,49 m de haut +



OP000711



Pieds articulés réglables
tous les 20 mm sur 230 mm +



1 SAC ÉTANCHE 30L OFFERT

	Hauteur replié (m)	Hauteur déployé (m)	Poids (kg)	CODE PROMO Gencod	PRIX PROMO Tarif 2025
	1,72	2,05 / 2,29	25	OP000711 3178740228705	786 €HT 1479 €HT

NOUVEAUX MODÈLES

LOT DE 2 MAXIBAT

Norme EN 131



PRODUIT RESPONSABLE

L'incontournable des chantiers



OP000891

LOT DE 2 KOLOS

Norme EN 131



Articulations et repose-pieds en composite ultra-résistant garantis 25 ans

Marches extra-larges 110 mm



OP000942

	Hauteur accès maxi (m)	Poids (kg)	CODE PROMO Gencod	PRIX PROMO Tarif 2025
Lot de 2 - 3 marches	2,66	8,6	OP000889 3178740252441	196€ HT 548€ HT
Lot de 2 - 4 marches	2,89	10	OP000890 3178740252458	222€ HT 618€ HT
Lot de 2 - 5 marches	3,12	10,6	OP000891 3178740252465	233€ HT 614€ HT
Lot de 2 - 6 marches	3,36	13,4	OP000892 3178740252472	268€ HT 726€ HT
Lot de 2 - 7 marches	3,59	14,8	OP000893 3178740252488	289€ HT 784€ HT

	Hauteur accès maxi (m)	Poids (kg)	CODE PROMO Gencod	PRIX PROMO Tarif 2025
Lot de 2 - 3 marches	2,66	9,4	OP000940 3178740253073	268€ HT 634€ HT
Lot de 2 - 4 marches	2,89	11,4	OP000941 3178740253080	289€ HT 716€ HT
Lot de 2 - 5 marches	3,12	13,4	OP000942 3178740253097	309€ HT 736€ HT
Lot de 2 - 6 marches	3,36	15,4	OP000943 3178740253103	361€ HT 878€ HT
Lot de 2 - 7 marches	3,59	17,8	OP000944 3178740253110	392€ HT 952€ HT

TETRIS

Norme PIRL NF P 93353



Décalage de niveau

	Hauteur travail maxi (m)	Poids (kg)	CODE PROMO Gencod	PRIX PROMO Tarif 2025
	3,00 m	29,65	OP000173 3534740150352	584€ HT 1171€ HT

HELIS

Norme PIRL NF P 93353



Spécial escalier



	Hauteur travail maxi (m)	Poids (kg)	CODE PROMO Gencod	PRIX PROMO Tarif 2025
	2,68 m	30,56	03121002 3534740125961	686€ HT 1298€ HT



LOT DE 2 DOUBLE DE CHANTIER

Norme EN 131



DOUBLE ACCÈS

NOUVEAU

Norme EN 131*
* sauf 2 marches sans garde-corps (normé EN 14183)

Avec ou sans garde-corps
Surface d'appui confortable

Montants anodisés
Marches 90 mm



OP000305



OP000972



OP000977

	Hauteur accès maxi (m)	Poids (kg)	CODE PROMO Gencod	PRIX PROMO Tarif 2025
Lot de 2 - 3 marches	2,45	8,8	OP000305 3534740156705	354€ HT 828€ HT
Lot de 2 - 4 marches	2,67	11,6	OP000306 3534740156712	429€ HT 1048€ HT

	Hauteur accès maxi (m)	Poids (kg)	CODE PROMO Gencod	PRIX PROMO Tarif 2025
2 marches	2,48	3,5	OP000971 3178740260637	116€ HT 215€ HT
3 marches	2,23	5,2	OP000972 3178740260644	151€ HT 281€ HT
4 marches	2,46	6,5	OP000973 3178740260651	177€ HT 329€ HT
5 marches	2,70	8	OP000974 3178740260668	201€ HT 374€ HT
6 marches	2,93	9,6	OP000975 3178740260675	223€ HT 414€ HT
3 marches avec garde-corps	2,46	7,3	OP000976 3178740260682	209€ HT 373€ HT
4 marches avec garde-corps	2,69	8,6	OP000977 3178740260689	237€ HT 424€ HT



LOT DE 2 COBRA



Plateau équipé de bandes rugueuses antidérapantes

	Hauteur accès maxi (m)	Poids (kg)	CODE PROMO Gencod	PRIX PROMO Tarif 2025
Lot de 2	2,50	15,6	OP000445 3178740168070	285€ HT 564€ HT
Lot de 5	2,50	39	OP000446 3178740168087	646€ HT 1418€ HT

CONFORT PLIANT

Norme EN 14183



Marches larges 200 mm
Porte-outils textile

	Hauteur accès maxi (m)	Poids (kg)	CODE PROMO Gencod	PRIX PROMO Tarif 2025
3 marches	2,71	7	OP000685 3178740224356	269€ HT 492€ HT

TÉLESCOPIQUES

ARTIPLI

Norme EN 131-4



Plate-forme en acier antidérapante

CODE PROMO Gencod	Poids (kg)	PRIX PROMO Tarif 2025
OP000783 3178740240783	12	232€HT 472€HT

MULTISCOPIC

Norme EN 131-4



Travail sur sol plat ou en escalier



OP000785

	Poids (kg)	CODE PROMO Gencod	PRIX PROMO Tarif 2025
4x3 échelons	9.7	OP000784 3178740240790	266€HT 545€HT
4x4 échelons	11.9	OP000785 3178740240806	334€HT 682€HT
4x5 échelons	14.2	OP000873 3178740245887	413€HT 757€HT

LOT DE 2 X-TENSO 2

Norme EN 131-6



Coulissement de l'échelle sûre et sans grippage



OP000701

	Poids (kg)	CODE PROMO Gencod	PRIX PROMO Tarif 2025
Lot de 2- 2,90 m	19.2	OP000700 3178740226619	520€HT 1050€HT
Lot de 2- 3,20 m	24.8	OP000701 3178740226626	596€HT 1248€HT
Lot de 2- 3,80 m	32.4	OP000702 3178740226633	684€HT 1434€HT
Lot de 2- 4,40 m	42	OP000703 3178740226640	1051€HT 2120€HT

FLEX'UP

Norme EN 131-4



Polyvalente et compacte



OP000886

	Hauteur accès maxi (m)	Poids (kg)	CODE PROMO Gencod	PRIX PROMO Tarif 2025
4x4	4.89	14.1	OP000886 3178740248260	424€HT 730€HT
4x5	5.93	17.1	OP000887 3178740248277	475€HT 832€HT

FLEX'UP + NOUVEAU MODÈLE

Disponible fin janvier

Norme EN 131-4



2 pieds réglables sur le même côté



OP000980

	Hauteur accès maxi (m)	Poids (kg)	CODE PROMO Gencod	PRIX PROMO Tarif 2025
4x4 échelons 2 pieds réglables	4.85	15.1	OP000980 3178740260705	455€HT 767€HT

PRONOR TRANSFORMABLE

Norme EN 131



Échelons 30 x 30 mm



OP000682

OP000510

	Hauteur accès maxi (m)	Poids (kg)	CODE PROMO Gencod	PRIX PROMO Tarif 2025
2 plans - 2x9	5.26	10.8	OP000507 3178740197162	272€HT 485€HT
2 plans - 2x12	6.95	15.5	OP000682 3178740224332	413€HT 726€HT
3 plans - 3x9	6.87	19.2	OP000633 3178740214562	447€HT 845€HT
3 plans - 3x12	8.83	25.2	OP000510 3178740197193	609€HT 1202€HT

ACCESSOIRES

ATTACHE ÉCHELLE



Jusqu'à 3 sections d'échelles
Livré par 2

Poids (kg)	CODE PROMO Gencod	PRIX PROMO Tarif 2025
2.8	OP000882 3178740246006	99€HT 161€HT

TAPIS ÉCHELLE

Compatible avec nos échelles et nos marchepieds d'une largeur < 126 cm

Poids (kg)	CODE PROMO Gencod	PRIX PROMO Tarif 2025
7.6	OP000934 3178740253011	45€HT 80€HT



ÉCHELLE DE TOIT

EVOKLIP

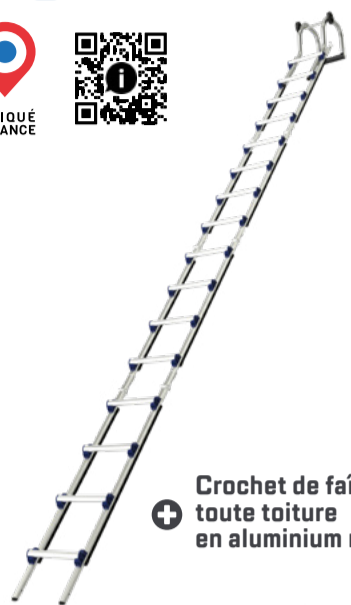

+ Crochet de faitage toute toiture en aluminium monobloc

OP000608



	Longueur maxi (m)	Poids (kg)	CODE PROMO Gencod	PRIX PROMO Tarif 2025
PACK 250 mm (4 échelles +1 crochet de faitage)	6.69	23.2	OP000607 3178740208929	1106 €HT 2273 €HT
PACK 330 mm (4 échelles +1 crochet de faitage)	7.29	22.4	OP000608 3178740208936	1025 €HT 2115 €HT
PACK 390 mm (4 échelles +1 crochet de faitage)	6.93	20	OP000609 3178740208943	973 €HT 2060 €HT

PLATINIUM COULISSE À MAIN 2 PLANS

Norme **EN 131**



+ Ultra-résistance de l'échelon grâce au triple sertissage

OP000656

OP000680

	Hauteur replié (m)	Hauteur déployé (m)	Hauteur accès maxi (m)	Poids (kg)	CODE PROMO Gencod	PRIX PROMO Tarif 2025
A crochets 2 plans 2x7	2.06	3.46	4.40	7.2	OP000656 3178740220662	269 €HT 529 €HT
A crochets 2 plans 2x8	2.34	4.02	4.96	8.1	OP000657 3178740220679	300 €HT 583 €HT
avec embase 2 plans 2x7	2.08	3.50	4.40	7.7	OP000680 3178740224318	274 €HT 533 €HT
avec embase 2 plans 2x8	2.36	4.06	4.96	8.7	OP000681 3178740224325	299 €HT 581 €HT

PLATINIUM 300 COULISSE À CORDE 2 / 3 PLANS

Norme **EN 131**



+ Roulettes de déploiement noires non tachantes



OP000674

OP000677

	Hauteur replié (m)	Hauteur déployé (m)	Hauteur accès maxi (m)	Poids (kg)	CODE PROMO Gencod	PRIX PROMO Tarif 2025
2 plans 2x10	2.97	4.93	5.83	19.5	OP000674 3178740224257	657 €HT 1075 €HT
2 plans 2x14	4.09	6.89	7.79	24	OP000675 3178740224264	730 €HT 1201 €HT
2 plans 2x18	5.22	9.14	10.04	33.5	OP000676 3178740224271	1019 €HT 1690 €HT
3 plans 3x10	2.98	6.90	7.80	27	OP000677 3178740224288	1086 €HT 1810 €HT
3 plans 3x18	5.23	12.49	13.39	53.5	OP000679 3178740224301	1724 €HT 2843 €HT

PLATINIUM 500 COULISSE À CORDE 2 / 3 PLANS

Norme **EN 131**



+ Échelons orientés de 30 x 30 mm



OP000616

OP000619

	Hauteur replié (m)	Hauteur déployé (m)	Hauteur accès maxi (m)	Poids (kg)	CODE PROMO Gencod	PRIX PROMO Tarif 2025
2 plans 2x11	2.98	4.98	5.88	20.6	OP000616 3178740214418	683 €HT 1112 €HT
2 plans 2x16	4.23	6.98	7.88	26.9	OP000617 3178740214425	824 €HT 1349 €HT
2 plans 2x20	5.23	8.98	9.88	36.6	OP000618 3178740214432	1082 €HT 1769 €HT
3 plans 3x11	3.00	7.00	7.90	31.4	OP000619 3178740214449	1170 €HT 1913 €HT
3 plans 3x18	4.74	11.24	12.14	47.9	OP000509 3178740197186	1682 €HT 2736 €HT

MONTANA

Norme **NF EN 12158-2** | Conforme **Directive machine 2006-42-CE**



CODE	DÉSIGNATION	A	B	C
05022900	MONTANA 10 m avec genouillère	1	1	1
05022907	MONTANA/NEVADA Échelle 2 m	1	3	5

Treuil amovible pour plus de sûreté +

	Poids (kg)	CODE PROMO Gencod	PRIX PROMO Tarif 2025
A - Montana 12 m	206	OP000101 3534740144665	7686 €HT 13718 €HT NEW
B - Montana 16 m	229	OP000485 3534740163413	8445 €HT 14932 €HT NEW
C - Montana 20 m	262	OP000102 3534740144672	8804 €HT 16154 €HT NEW



OP000101

NEVADA

Norme **NF EN 12158-2** | Conforme **Directive machine 2006-42-CE**



CODE	DÉSIGNATION	A	B	C	D
05020918	NEVADA 7 m droit sans genouillère	1	1	-	-
05020011	NEVADA 10 m avec genouillère	-	-	1	1
05022908	MONTANA/NEVADA Échelle 1 m	-	-	1	1
05022907	MONTANA/NEVADA Échelle 2 m	-	-	-	2
00034138	Lot de 5 axes 87073	-	-	1	2
00034256	Sachet de 10 vis à oreilles	-	-	1	1
00034137	Lot de 5 goupilles 85098	-	-	1	2

Genouillère 0 à 60° +

	Poids (kg)	CODE PROMO Gencod	PRIX PROMO Tarif 2025
A - Nevada 7 m droit	148	OP000950 3534740177625	5040 €HT 7817 €HT NEW
B - Nevada 7 m droit + kit photovoltaïque	160	OP000956 3534740177915	5242 €HT 8029 €HT NEW
C - Nevada 11 m	176,55	OP000131 3534740148519	5698 €HT 8836 €HT NEW
D - Nevada 15 m	198,65	OP000132 35347401148533	6361 €HT 10231 €HT NEW



OP000950

OP000131

APACHE

Norme **NF EN 12158-2** | Conforme **Directive machine 2006-42-CE**



CODE	DÉSIGNATION	A	B	C	D
05011925	APACHE 7 m droit sans genouillère	1	1	-	-
05011010	APACHE 10,60 m avec genouillère	-	-	1	1
00027305	Échelle 1 m APACHE	-	-	1	-
05011902	Pack Confort APACHE	-	-	-	1
00034122	Lot de 5 goupilles 80466	-	-	1	-

Caisse interchangeable +

	Poids (kg)	CODE PROMO Gencod	PRIX PROMO Tarif 2025
A - Apache 7 m droit	137,4	OP000949 3534740177618	3990 €HT 6252 €HT NEW
B - Apache 7 m droit + kit photovoltaïque	149	OP000955 3534740177908	4232 €HT 6594 €HT NEW
C - Apache 11,60 m	131,45	OP000122 3534740148090	4638 €HT 7258 €HT NEW
D - Apache 15 m	153	05011907 3534740119182	5094 €HT 7796 €HT NEW

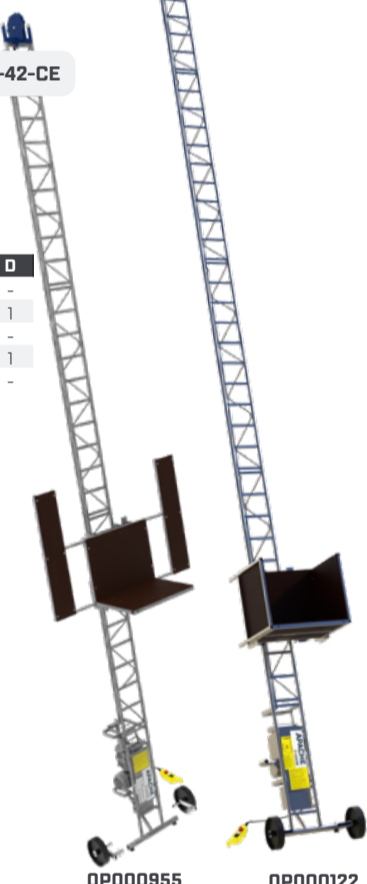

OP000955

OP000122

KITS

KIT PANNEAUX PHOTOVOLTAÏQUES APACHE / NEVADA

NOUVEAU



KIT ÉTAIEMENT - AMARRAGE NEVADA / MONTANA

Ce kit offre de multiples solutions d'amarrages ou d'étaisements :

- sur fenêtre
- sur échafaudage
- étaiyage double à partir du sol
- étaiyage en appui sur façade



PACK

PACK MAÇON APACHE



	Poids (kg)	CODE PROMO Gencod	PRIX PROMO Tarif 2025
Pack maçon Apache	53	OP000537 3534740167022	1498 €HT 2458 €HT NEW

NOUVEAU

SUBVENTION PRÉVENTION DES RISQUES ERGONOMIQUES :

Jusqu'à **70% d'aide** à l'achat de nos Apache, Nevada et Montana.
Plus d'informations : Ameli.fr

KIT ÉTAIEMENT AMARRAGE APACHE



	Poids (kg)	CODE PROMO Gencod	PRIX PROMO Tarif 2025
Kit photovoltaïque Apache / Nevada	11,34	OP000948 3534740177571	256 €HT 391 €HT NEW
Kit étaiyement amarrage Apache	26	OP000284 3534740154664	497 €HT 854 €HT NEW
Kit étaiyement amarrage Nevada / Montana	74	OP000285 3534740154671	1028 €HT 1859 €HT NEW
Kit confort 5 m Apache	32	OP000666 3534740172859	530 €HT 888 €HT NEW
Kit confort 4 m Nevada / Montana	28	OP000665 3534740172842	602 €HT 942 €HT NEW

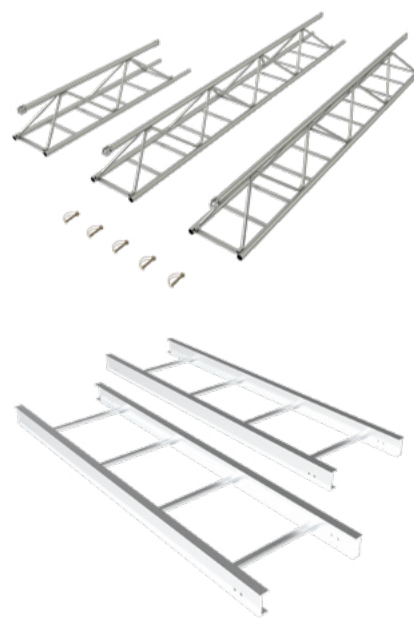

KIT CONFORT 5 M APACHE

KIT CONFORT 4 M NEVADA / MONTANA

- Ce pack permet de rehausser la structure de 4,00 m
- Hauteur maxi NEVADA = 20 m
- Hauteur maxi MONTANA = 32 m

VELOCE GARDE-CORPS SANGLES

Norme **PIRL NF P 93353***



4 roues escamotables +

Hauteur travail maxi (m)	Poids (kg)	CODE PROMO Gencod	PRIX PROMO Tarif 2025
2 marches	2,48	OP000900 3178740252670	633€HT 1128€HT
3 marches	2,70	OP000901 3178740252687	672€HT 1274€HT
4 marches	2,94	OP000902 3178740252694	728€HT 1368€HT
5 marches	3,17	OP000903 3178740252700	859€HT 1442€HT
6 marches	3,40	OP000904 3178740252717	914€HT 1605€HT
7 marches	3,63	OP000905 3178740252724	1014€HT 1781€HT



OP000902

* La marque NF certifie la conformité à la norme NF P 93-353 et au Référentiel NF096 (modèles 2 à 6 marches).

VELOCE GARDE-CORPS PORTILLON

Norme **EN 131-7 / PIRL NF P 93353**

NOUVEAU



Garde-corps avec portillon à fermeture automatique +

Hauteur travail maxi (m)	Poids (kg)	CODE PROMO Gencod	PRIX PROMO Tarif 2025
3 marches	2,70	OP000957 3178740256463	797€HT 1475€HT NEW
4 marches	2,94	OP000958 3178740256470	854€HT 1578€HT NEW
5 marches	3,17	OP000959 3178740256487	921€HT 1768€HT NEW



OP000958

Toutes les références sont conformes à la norme EN 131-7. La marque NF certifie la conformité à la norme NF P 93-353.

RAPTORSCOPIC GARDE-CORPS SANGLES OU LISSES

Norme **EN 131-7* / PIRL NF P 93353 / PIR NF P 93352**



Télescopique +

Hauteur travail maxi (m)	Poids (kg)	CODE PROMO Gencod	PRIX PROMO Tarif 2025
3/4 marches (garde-corps sangles)	2,95	OP000931 3178740252984	812€HT 1454€HT
5/7 marches (garde-corps sangles)	3,60	OP000932 3178740252991	1040€HT 1889€HT

VERSION GARDE-CORPS PLIANT

Hauteur travail maxi (m)	Poids (kg)	CODE PROMO Gencod	PRIX PROMO Tarif 2025
3/4 marches (garde-corps sangles)	2,95	OP000969 3178740256982	942€HT 1683€HT NEW
3/4 marches (garde-corps lisses)	2,95	OP000970 3178740256989	1009€HT 1861€HT NEW



OP000970

La marque NF certifie la conformité à la norme NF P 93-353 (modèle 3-4 marches), à la norme NF P 93-352 (modèle 5-7 marches) et au Référentiel NF096. * Seul le modèle avec garde-corps lisses est conforme à la norme EN 131-7.

LOT DE 2 RAPTOR GARDE-CORPS SANGLES

Norme **PIRL NF P 93353 / PIR NF P 93352**



Porte-outils compartimenté amovible +

Hauteur travail maxi (m)	Poids (kg)	CODE PROMO Gencod	PRIX PROMO Tarif 2025
LOT de 2 2 marches	2,48	OP000894 3178740252618	871€HT 1566€HT
LOT de 2 3 marches	2,70	OP000895 3178740252625	1000€HT 1852€HT
LOT de 2 4 marches	2,94	OP000896 3178740252632	1052€HT 2026€HT
LOT de 2 5 marches	3,17	OP000897 3178740252649	1263€HT 2412€HT
LOT de 2 6 marches	3,40	OP000898 3178740252656	1361€HT 2598€HT
LOT de 2 7 marches	3,63	OP000899 3178740252663	1516€HT 2868€HT



OP000896

La marque NF certifie la conformité à la norme NF P 93-353 (modèles 2 à 6 marches), à la norme NF P 93-352 (modèle 7 marches) et au Référentiel NF096.

SHERPA ISOLANT

Norme **EN 131-7 / PIRL NF P 93353 / Test électrique conforme EN50528**



Fibre de verre +

Hauteur travail maxi (m)	Poids (kg)	CODE PROMO Gencod	PRIX PROMO Tarif 2025
3 marches	2,71	OP000918 3178740252854	912€HT 1678€HT
4 marches	2,94	OP000919 3178740252861	1005€HT 1826€HT
5 marches	3,17	OP000920 3178740252878	1154€HT 2197€HT



OP000919

STABIL

Conforme au texte **NF E 85301**



Roulettes escamotables +

Hauteur travail maxi (m)	Poids (kg)	CODE PROMO Gencod	PRIX PROMO Tarif 2025
1 marche	2,30	OP000960 3178740256494	514€HT 978€HT
2 marches	2,50	OP000961 3178740256500	564€HT 1064€HT



OP000961

SHERPAMATIC GARDE-CORPS PORTILLON

Norme EN 131-7 / PIRL NF P 93353 / PIR NF P 93352



Grutable +



OP000915

LOT DE 2 SHERPAMATIC GARDE-CORPS LISSES

Norme EN 131-7 / PIRL NF P 93353 / PIR NF P 93352



Plancher grand confort +
600 x 400 mm



OP000909

Hauteur travail maxi (m)	Poids (kg)	CODE PROMO Gencod	PRIX PROMO Tarif 2025
3 marches	2,70	OP000912 3178740252793	699 € HT 1302 € HT
4 marches	2,94	OP000913 3178740252809	764 € HT 1433 € HT
5 marches	3,18	OP000914 3178740252816	837 € HT 1566 € HT
6 marches	3,41	OP000915 3178740252823	895 € HT 1677 € HT
7 marches	3,64	OP000916 3178740252830	947 € HT 1768 € HT
8 marches	3,87	OP000917 3178740252847	993 € HT 1859 € HT

Organisme certificateur: **AFNOR Certification**, 11, rue Francis de Pressensé, F-93571 La Plaine Saint Denis Cedex
Référéntiel de certification: NF équipements de chantier (NF096) disponible sur www.marque-nf.com
La marque NF certifie la conformité à la norme **NF P 93-352** (pour les PIR) et **NF P 93-353** (pour les PIRL).

Toutes les références sont conformes à la norme EN 131-7. La marque NF certifie la conformité à la norme NF P 93-353 (modèles 3 à 6 marches), à la norme NF P 93-352 (modèles 7 et 8 marches) et au Référentiel NF096.

Hauteur travail maxi (m)	Poids (kg)	CODE PROMO Gencod	PRIX PROMO Tarif 2025
LOT de 2-3 marches	2,70	OP000906 3178740252731	1303 € HT 2510 € HT
LOT de 2-4 marches	2,94	OP000907 3178740252748	1355 € HT 2608 € HT
LOT de 2-5 marches	3,18	OP000908 3178740252755	1479 € HT 2814 € HT
LOT de 2-6 marches	3,41	OP000909 3178740252762	1583 € HT 2922 € HT
LOT de 2-7 marches	3,64	OP000910 3178740252779	1668 € HT 3082 € HT
LOT de 2-8 marches	3,87	OP000911 3178740252786	1771 € HT 3222 € HT

Toutes les références sont conformes à la norme EN 131-7. La marque NF certifie la conformité à la norme NF P 93-353 (modèles 3 à 6 marches), à la norme NF P 93-352 (modèles 7 et 8 marches) et au Référentiel NF096.

SHERPASCOPIC GARDE-CORPS PORTILLON

Norme EN 131-7 / PIRL NF P 93353 / PIR 93352



Robuste et télescopique +



OP000926

LOT DE 2 SHERPASCOPIC GARDE-CORPS LISSES

Norme EN 131-7 / PIRL NF P 93353 / PIR NF P 93352



Porte-outils et tablette interchangeables +



OP000922

Hauteur travail maxi (m)	Poids (kg)	CODE PROMO Gencod	PRIX PROMO Tarif 2025
3/4 marches	2,95	OP000925 3178740252822	1076 € HT 1971 € HT
5/7 marches	3,61	OP000926 3178740252839	1417 € HT 2586 € HT
8/10 marches	4,30	OP000927 3178740252846	1686 € HT 2977 € HT
8/11 marches	4,50	OP000928 3178740252853	1800 € HT 3282 € HT

VERSION GARDE-CORPS PLIANT

Hauteur travail maxi (m)	Poids (kg)	CODE PROMO Gencod	PRIX PROMO Tarif 2025
5/7 marches	3,61	OP000930 3178740252977	1579 € HT 2947 € HT

Tous les modèles sont conformes à la norme EN 131-7. La marque NF certifie la conformité à la norme NF P 93-353 (modèle 3-4 marches), à la norme NF P 93-352 (modèles 5-7 marches et au-delà) et au Référentiel NF096.



OP000930
Version garde-corps pliant

Hauteur travail maxi (m)	Poids (kg)	CODE PROMO Gencod	PRIX PROMO Tarif 2025
LOT de 2-3/4 marches	2,95	OP000921 3178740252885	1915 € HT 3608 € HT
LOT de 2-5/7 marches	3,61	OP000922 3178740252892	2399 € HT 4438 € HT
LOT de 2-8/10 marches	4,30	OP000923 3178740252908	2905 € HT 5584 € HT
LOT de 2-8/11 marches	4,50	OP000924 3178740252915	3183 € HT 5898 € HT

VERSION GARDE-CORPS PLIANT

Hauteur travail maxi (m)	Poids (kg)	CODE PROMO Gencod	PRIX PROMO Tarif 2025
LOT de 2-5/7 marches	3,61	OP000929 3178740252980	2857 € HT 5358 € HT

Tous les modèles sont conformes à la norme EN 131-7. La marque NF certifie la conformité à la norme NF P 93-353 (modèle 3-4 marches), à la norme NF P 93-352 (modèles 5-7 marches et au-delà) et au Référentiel NF096.



OP000929
Version garde-corps pliant

RAPTOR

VELOCE

RAPTORSCOPIC

SHERPASCOPIC

SHERPAMATIC

SHERPA ISOLANT

NOUVEAU
VELOCE GARDE-CORPS PORTILLON

NOUVEAU
RAPTORSCOPIC GARDE-CORPS PLIANT

- Versions garde-corps lisses ou sangles
- Hauteur replié 160 cm seulement

À PARTIR DE **435,5 €HT** !

p.18-19

SÉCURITÉ

CONFORT

ÉCO-CONCEPTION

NEOLIUM EVO

POUR ÊTRE **AGILE**
SUR VOS CHANTIERS,
MÊME EN **SOLO**

SE TRANSFORME
RAPIDEMENT EN
CHARIOT MOBILE

PRIX PROMO
2022 €HT !

p.11

PRIX PROMO
3039 €HT !

p.11



IMPRIMÉ
EN FRANCE

